

Article number: 20343160M12KRE

Description: E+G levelling foot
GN 343.1-60-M12-KRE

Measures

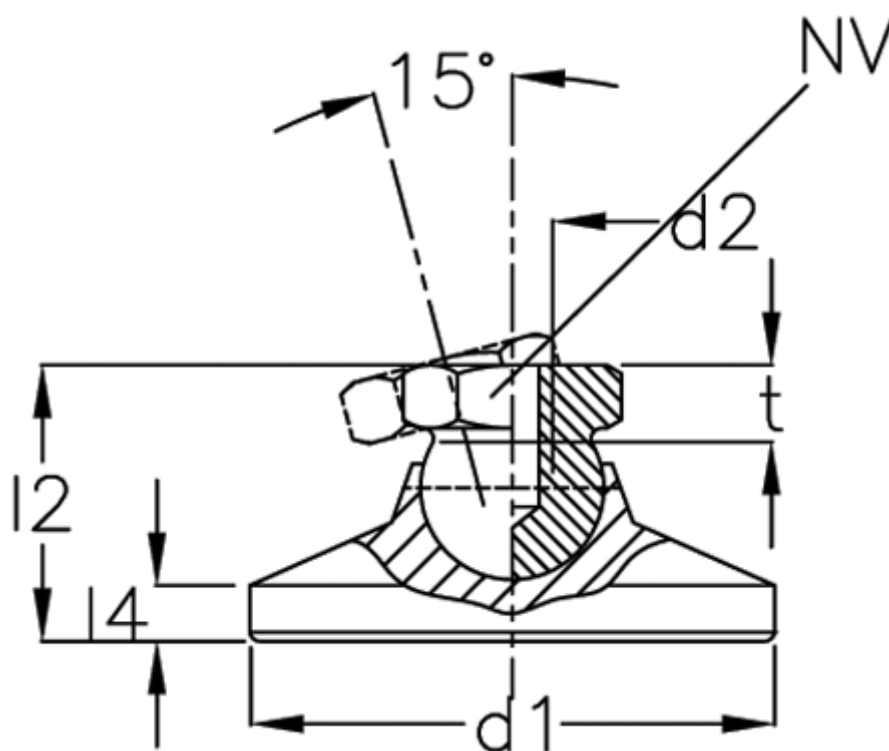

d1	= 60
d2	= 12
l2	= -
l4	= -
NV	= 17
Static load (kN)	= 30
t min	= 11.5